

Modulation of CNS Signal Transduction Pathways and Gene Expression by Mood-Stabilizing Agents: Therapeutic Implications

Husseini K. Manji, M.D.; Joseph M. Bebchuk, M.D.; Gregory J. Moore, Ph.D.; Debra Glitz, M.D.; Khondakar A. Hasanat, M.D.; and Guang Chen, M.D.

In an attempt to find the key to reducing the excessive morbidity and mortality seen with mood disorders, our laboratory has been extensively investigating lithium's mechanisms of action in an integrated series of clinical and preclinical studies. We have found that the chronic administration of the 2 structurally highly dissimilar agents, lithium and valproate, brings about a strikingly similar reduction in protein kinase C (PKC) α and ϵ isozymes in rat frontal cortex and hippocampus. In view of PKC's critical role in regulating neuronal excitability and neurotransmitter release, we have postulated that PKC inhibition may have antimanic efficacy. In a small study, we have found that tamoxifen (which, in addition to its estrogen receptor blockade, is also a PKC inhibitor) has marked antimanic efficacy. These exciting preliminary results suggest that PKC inhibitors may represent a novel class of improved therapeutic agents for bipolar disorder, and this is under further investigation. The beneficial effects of mood stabilizers require a lag period for onset of action and are generally not immediately reversed upon drug discontinuation; such patterns of effects suggest alterations at the genomic level. We have therefore undertaken a series of studies to investigate the effects of these agents on the AP-1 family of transcription factors and have found that both drugs increase AP-1 DNA binding activity in areas of rodent brain *ex vivo* and in human neuronal cells in culture. Both treatments also increase the expression of a reporter gene driven by an AP-1-containing promoter, and mutations in the AP-1 sites of the reporter gene promoter markedly attenuate these effects. Both treatments also increase the expression of several *endogenous* proteins, whose genes are known to be regulated by AP-1. Although the precise mechanisms have not been fully elucidated, preliminary results suggest that these effects may be mediated, in part, by mitogen-activating protein kinases and glycogen synthase kinase 3 β . We have also utilized mRNA reverse transcription-polymerase chain reaction (RT-PCR) differential display to identify concordant changes in gene expression induced by the chronic administration of both lithium and valproate. We have identified concordant changes in a number of cDNA bands by both lithium and valproate. Cloning and characterizing of these genes is currently underway. The identification of the functions of these genes offers the potential not only for improved therapeutics for reducing the morbidity and mortality associated with mood disorders, but may also provide important clues about the underlying pathophysiology. *(J Clin Psychiatry 1999;60[suppl 2]:27-39)*

From the Schizophrenia and Mood Disorders Clinical Research Division, Departments of Psychiatry and Behavioral Neurosciences, Wayne State University School of Medicine, Detroit, Mich.

Supported in part by Theodore and Vada Stanley Foundation and Joseph Young Senior Foundation Research Awards. The authors acknowledge the invaluable assistance of the Nursing and Research Staff of the Neuropsychiatric Research Unit, and Ms. Celia Knobelsdorf for outstanding editorial assistance.

Presented at the symposium "Effects of Medical Interventions on Suicidal Behavior," which was held February 26-28, 1998, Miami, Fla., cosponsored by the American Foundation for Suicide Prevention, the Johns Hopkins University School of Medicine, and the Long Island Jewish Medical Center, with the cooperation of the Suicide Prevention Advocacy Network, and supported by an educational grant from Solvay Pharmaceuticals, Inc.

Reprint requests to: Husseini K. Manji, M.D., Director, Schizophrenia and Mood Disorders Clinical Research Division, WSU School of Medicine, VHC 9B, 4201 St. Antoine Blvd., Detroit, MI 48201.

Bipolar affective disorder (manic-depressive illness) is a common, severe, chronic and often life-threatening illness.¹ Suicide is the cause of death in 10% to 20% of individuals with either bipolar or recurrent depressive disorders, and the risks of suicide in bipolar disorder may be higher than those in unipolar depression (reviewed in Simpson and Jamison,² this volume). In addition to suicide, major mood disorders are also associated with many other deleterious health-related effects, and the costs associated with disability and premature death represent an economic burden of tens of billions of dollars annually in the United States alone.^{3,4} Despite the devastating impact that these illnesses have on the lives of millions, there is still a dearth of knowledge concerning the etiology of recurrent mood disorders.

The discovery of lithium's efficacy as a mood-stabilizing agent revolutionized the treatment of patients

with bipolar disorder—indeed, it is likely that the remarkable efficacy of lithium has, in fact, served to spark a revolution that has, over time, reshaped not only medical and scientific, but also popular concepts of severe mental illnesses. After nearly 3 decades of use in North America, lithium continues to be the mainstay of treatment for this disorder, both for the acute manic phase and as prophylaxis for recurrent manic and depressive episodes.^{1,5,6} Numerous placebo-controlled studies have unequivocally documented the efficacy of lithium in the long-term prophylactic treatment of bipolar disorder, and the beneficial effects appear to involve both a reduction in the number of episodes, as well as their intensity (reviewed in Goodwin and Jamison¹). There is now compelling evidence that adequate lithium treatment, particularly in the context of a lithium clinic, also reduces the excessive mortality observed in the illness (reviewed in references 5, 7, and 8).

However, despite lithium's role as one of psychiatry's most important treatments, the cellular and molecular basis for its mood-stabilizing and mortality-lowering effects remains to be fully elucidated.^{9,10} Furthermore, increasing evidence suggests that a significant number of patients respond poorly to lithium therapy, with several studies reporting that 20% to 40% of patients fail to show an adequate antimanic response to lithium, while many others are helped but continue to suffer significant morbidity.^{11,12} The recognition of the significant morbidity and mortality of the severe mood disorders, as well as the growing appreciation that a significant percentage of patients respond poorly to existing treatments, has made the task of discovering new therapeutic agents that work quickly, potently, specifically, and with fewer side effects increasingly more important. This awareness has led to extensive investigation of other pharmacologic agents both for the treatment of acute mania and for the long-term prophylaxis of bipolar disorder, and considerable evidence has shown the anticonvulsants, divalproex and carbamazepine, to be efficacious.¹³⁻¹⁶ Double-blind studies have demonstrated that divalproex can work as effectively as lithium in the treatment of acute mania,¹⁵ and, with oral loading, may bring about a more rapid remission of manic symptoms than lithium.¹⁷ Although, to date, the body of data from controlled studies is small, evidence also suggests that divalproex is effective in the long-term prophylaxis of bipolar disorder.¹⁸ Considerable evidence has also shown that carbamazepine is an alternative or adjunctive treatment to lithium, both for acute manic episodes and for long-term prophylaxis in bipolar disorder.^{13,19}

In addition to identifying much needed additions to our therapeutic armamentarium, the recognition of the therapeutic efficacy of these structurally very dissimilar compounds not only offers the potential for the elucidation of the targets both common to and unique among the different agents, but may also help to identify the biochemical substrates predisposing individuals to bipolar disorder.^{19,20}

To date, however, the molecular mechanisms underlying the therapeutic actions of lithium, divalproex, or carbamazepine have not been fully elucidated.^{10,19-23} Although a number of acute in vitro effects of these agents have been identified, their therapeutic effects in the treatment of manic depressive illness are seen only after chronic administration, thereby precluding any simple mechanistic interpretations based on their acute biochemical effects. The search for the mechanisms of action of mood-stabilizing agents has been facilitated by a growing appreciation that, rather than any single neurotransmitter system being responsible for depression or mania, multiple interacting and overlapping systems are involved in regulating mood, and that most effective drugs likely do not work on any particular neurotransmitter system in isolation, but rather affect the functional balance between interacting systems. In this context, signal transduction pathways are in a pivotal position in the CNS²⁴⁻²⁷ and thus represent attractive targets to explain the efficacy of mood stabilizers in treating multiple aspects of bipolar disorder.^{10,28} It is therefore not surprising that, in recent years, research aimed at the elucidation of the molecular mechanisms underlying the therapeutic effects of mood-stabilizing agents has focused on second messenger generating systems, most notably the phosphoinositide/protein kinase C pathway and signal transducing guanine nucleotide-binding proteins (G proteins).

LITHIUM AND THE PHOSPHOINOSITIDE CYCLE: IS THE INOSITOL DEPLETION HYPOTHESIS A VALID MODEL?

Over the last decade, research on the cellular mechanisms underlying lithium's therapeutic effects has focused on intracellular second messenger generating systems and, in particular, receptor-coupled hydrolysis of phosphatidylinositol 4,5-bisphosphate (PIP₂). Although inositol phospholipids are relatively minor components of cell membranes, they play a major role in receptor-mediated signal transduction pathways and are involved in a diverse range of responses in the central nervous system (reviewed in references 29-34). Activation of a variety of neurotransmitter receptor subtypes (including muscarinic M₁, M₃, and M₅; noradrenergic α₁; serotonergic 5-HT₂; and several metabotropic glutamatergic receptors) induces the hydrolysis of membrane phospholipids. In brief, agonists such as acetylcholine, norepinephrine, serotonin, or glutamate bind to specific cell surface receptors, which interact with G proteins. These proteins stimulate certain isoforms of the enzyme phospholipase C (PLC). Activated PLC catalyzes the conversion of PIP₂ to 2 second messengers, inositol 1,4,5-trisphosphate (IP₃) and diacylglycerol (DAG). IP₃ stimulates the mobilization of intracellular Ca⁺⁺, while DAG activates protein kinase C (PKC). IP₃ can be phosphorylated and dephosphorylated, leading to other inositol phosphate compounds or to unphosphorylated inositol.

Figure 1. Effects of Lithium on the Phosphoinositide Cycle*

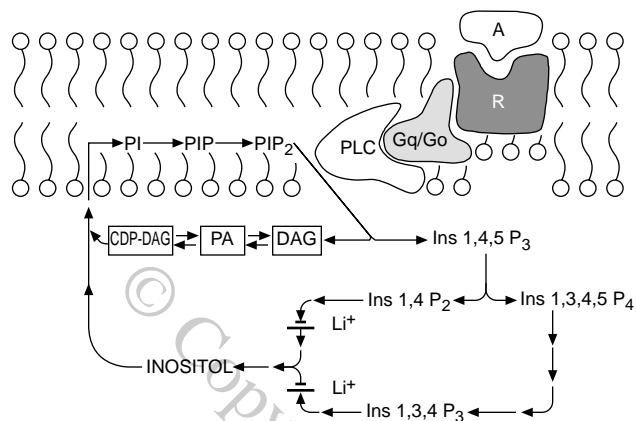

*Reproduced with modifications and permission from Manji et al., 1995.¹⁰ In this scheme, occupancy of the receptor (R) by a specific agonist (A) initiates the hydrolysis of phosphatidylinositol 4,5-bisphosphate (PIP₂) by phospholipase C (PLC). The signal from the receptor is conveyed to the effector (PLC) by G proteins (usually G_i and/or G_o). Hydrolysis of PIP₂ by PLC results in the formation of 2 major second messengers—inositol 1,4,5-trisphosphate (IP₃) and diacylglycerol (DAG). IP₃ mobilizes calcium from intracellular stores, whereas DAG activates PKC. IP₃ is either dephosphorylated to form Ins P₂, Ins P₁, and, ultimately, free inositol or phosphorylated to form Ins 1,3,4,5-P₄, which is then desphosphorylated by sequential distinct pathways. Lithium, at therapeutically relevant concentrations, inhibits the dephosphorylation of Ins 1,3,4-P₃, Ins 1,4-P₂, and all 3 forms of inositol phosphates (not shown in detail in the figure). Since in the brain *myo*-inositol is derived primarily from recycling of inositol phosphates, one consequence of lithium's action may be to reduce the levels of free *myo*-inositol.

Inositol in turn is converted to phosphatidylinositol, which in turn is phosphorylated to phosphatidylinositolphosphate (PIP) and PIP₂ (Figure 1).

The ability of a cell to maintain sufficient supplies of *myo*-inositol is crucial to the resynthesis of the phosphoinositides and the maintenance and efficiency of signaling. Lithium, at therapeutically relevant concentrations, is an inhibitor of inositol monophosphatase (IMPase) ($K_i = 0.8$ mM) and results in an accumulation of inositol-1-monophosphate as well as a reduction in free inositol.^{35,36} Lithium also inhibits inositol polyphosphate-1-phosphatase, which is involved in recycling inositol polyphosphates to inositol. Furthermore, since the mode of enzyme inhibition is *uncompetitive*, lithium's effects have been postulated to be most pronounced in systems undergoing the highest rate of PIP₂ hydrolysis (see reviews in Nahorski et al.^{37,38}). Thus, Berridge and associates^{39,40} first proposed that the physiologic consequence of lithium's action is derived through a *depletion* of free inositol and that its selectivity could be attributed to its preferential action (due to the *uncompetitive* nature of the inhibition) on the most overactive receptor-mediated neuronal pathways. For these reasons, it has been hypothesized that a physiologic consequence of lithium's action is derived through a depletion of free *myo*-inositol in the brain—the “inositol depletion hypothesis.”^{39,40} Since several subtypes of adrenergic,

cholinergic, serotonergic, and metabotropic glutamatergic receptors are coupled to PIP₂ hydrolysis in the brain, the inositol depletion hypothesis, as initially proposed, offered an attractive explanation for lithium's therapeutic efficacy in treating multiple aspects of bipolar disorder.

However, numerous studies have examined the effects of lithium on receptor-mediated phosphoinositide responses, and although some report a reduction in agonist-stimulated PIP₂ hydrolysis in rat brain slices following acute or chronic lithium, these findings have often been small and inconsistent and subject to numerous methodological differences (see Jope and Williams²⁸ for an excellent recent review). Additionally, several lines of evidence suggest that the action of chronic lithium may not simply be directly manifest in receptor-mediated phosphoinositide turnover. While investigators have observed that the levels of inositol in brain remain reduced in rats receiving chronic lithium,^{10,28,41} it has been difficult to demonstrate that this results in a reduction in the resynthesis of PIP₂, which is the substrate for agonist-induced phosphoinositide turnover. It has been proposed that this, however, may be due to the methodological difficulties in accurately measuring alterations in a rapidly turning over, small, signal-related pool of PIP₂ and that the resynthesis of inositol phospholipids may also occur through base exchange reactions from other larger pools of phospholipids such as phosphatidylcholine.⁴²

Thus, although the validity of the inositol depletion hypothesis as originally articulated²⁸ has been called into question, a large body of preclinical data suggests that some of the *initial* actions of lithium may occur with a relative depletion of *myo*-inositol⁴³⁻⁴⁸; this relative depletion of *myo*-inositol may initiate a cascade of secondary changes at different levels of the signal transduction process and gene expression in the CNS, effects that are ultimately responsible for lithium's therapeutic efficacy.^{10,28}

WHAT GENETIC FACTORS PLAY A ROLE IN DETERMINING TREATMENT RESPONSIVENESS?

It has been recognized in recent years that although lithium has had a remarkable beneficial effect on the lives of millions, a significant percentage of patients respond inadequately. With the growing recognition that bipolar disorder likely represents a heterogeneous group of disorders, the importance of identifying genetic, biochemical, or clinical predictors of differential treatment responsiveness or resistance has become increasingly appreciated. Although some important clinical leads have been identified,^{1,16,49-52} there is at present a dearth of knowledge about the genetic or biochemical factors associated with lithium responsiveness or resistance. Thus, there is a clear need to elucidate the genetic and/or biochemical mechanisms associated with responsiveness or resistance to lithium's

Figure 2. Typical Proton MRS Spectrum From the Frontal Lobe of a Bipolar Disorder Patient*

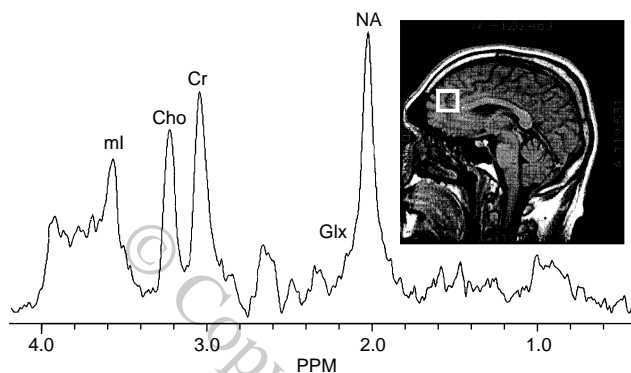

*Abbreviations: Cho = choline compounds, Cr = creatine/phosphocreatine, Glx = glutamate/glutamine, ml = *myo*-inositol, NA = *N*-acetyl-aspartate.

actions, not only to better identify patients likely to respond to lithium treatment, but also to facilitate the development of new therapeutic agents.

Recent genetic linkage studies suggesting the involvement of specific genes in bipolar disorder have elicited considerable excitement about the possibilities for improved treatment of this condition.^{53–56} Similar to other common and complex diseases like diabetes^{57,58} and hypertension,^{59,60} the inheritance of bipolar disorder appears to be multifactorial in nature rather than the result of simple Mendelian transmission (discussed in Philibert et al.⁶¹). It is thus not altogether surprising that (with a few notable recent exceptions) there has been a lack of replication of initial studies using linkage analysis. Differences in diagnostic criteria or the suspicion of etiologic heterogeneity has been cited as possible reasons for failure to replicate these data. Most recently, several independent research groups have reported linkage of bipolar disorder to disparate chromosomal regions—4p,⁶² 6p, 13q, and 15q,⁶³ and 18q.⁶⁴ An accompanying commentary by Risch and Botstein⁶⁵ attributed much of the uneven findings to the complex genetic mechanisms underlying the disease.

Linkage studies will undoubtedly continue to be an important means of exploring the etiology and selective treatment responsiveness of bipolar disorder, but there is a growing consensus that it is important to utilize additional approaches and methodologies to facilitate the identification of the biochemical pathways underlying the pathophysiology and/or selective treatment responsiveness of a disorder as complex as bipolar disorder. Another complementary and potentially very powerful strategy is to focus on certain biochemical pathways that have some a priori theoretical relevance to treatment responsiveness. In this context, it is noteworthy that the genomic structure of the human inositol monophosphatase gene has recently been reported and a polymorphism (G to A) has been identi-

Figure 3. In Vivo Proton MRS Test-Retest Stability/Reliability in 6 Healthy Volunteers*

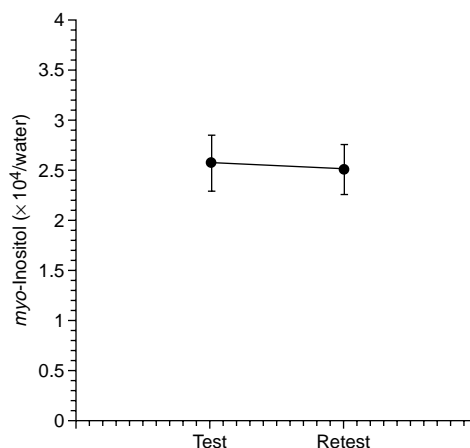

*Combined data (17 test-retest pairs) from the frontal, temporal, parietal, and occipital lobes.

fied.^{66,67} Interestingly, the same laboratory has reported that 2 additional *myo*-inositol monophosphatase gene (IMPA)-like transcripts originate from the human genome, 1 from a position close to IMPA itself on chromosome 8 and the other from chromosome 18p.⁶⁷ This research group is currently undertaking studies to determine if this polymorphism plays a role in determining responsiveness to lithium's therapeutic effects.⁶⁶

Our research group has recently undertaken a series of studies to determine (1) if lithium does indeed reduce the levels of *myo*-inositol in critical brain regions of individuals with bipolar disorder (it has never been demonstrated to occur in human brain) and (2) if individual differences in susceptibility to lithium-induced CNS *myo*-inositol reductions represent major factors determining resistance or responsiveness to lithium's therapeutic effects.

Proton magnetic resonance spectroscopy (MRS) spectra are acquired from 8cc regions of interest (ROIs) in the frontal, temporal, parietal, and occipital lobes, with an acquisition time of 5 min/ROI (STEAM pulse sequence TE = 30 msec, TM = 13.7 msec, TR = 2000 msec) (Figure 2). Using proton MRS, we have been able to quantitate *myo*-inositol concentration in the frontal, temporal, parietal, and occipital lobes with excellent reliability (Figure 3). Using a test-retest design (scan interval range, 1–12 weeks) in 6 healthy volunteer subjects, the brain *myo*-inositol concentration (expressed in units of *myo*-inositol × 10⁴/brain water and reported as the mean ± SE) was as follows: 2.571 ± 0.281 vs. 2.504 ± 0.243 with a mean difference of 0.068 or ± 3% of the *myo*-inositol measure, thus demonstrating that the temporal stability and test-retest reliability of this measure is remarkably good. In order to evaluate the interrater reliability of this method, 2 trained individuals analyzed the in vivo NMR data with MRUI-VARPRO time domain spectral analysis

software.^{68,69} The individuals were blind to the study information and to each other's results. Interclass correlation coefficient analysis revealed an interrater reliability of greater than 98%.

After extensive validation of this method for in vivo measurement of regional brain *myo*-inositol concentration, we have begun to apply this methodology in our studies of bipolar disorder patients undergoing lithium therapy. Our preliminary results show that therapeutic administration of lithium does, indeed, produce a significant brain-region specific reduction in *myo*-inositol levels in bipolar disorder patients (reference 70 and Moore GJ, Bechuk JM, Parrish JK, et al., manuscript in review). Studies are currently under way to determine if the lithium-induced reductions in *myo*-inositol levels are associated with components of the therapeutic response.

LITHIUM AND PROTEIN KINASE C: IMPLICATIONS FOR THE DEVELOPMENT OF NOVEL DRUGS FOR BIPOLAR DISORDER

In addition to the effects of lithium on phosphoinositide turnover, considerable recent research has clearly shown that the PKC signaling pathway is a target for the actions of chronic lithium (reviewed in Jope and Williams²⁸ and Manji et al.¹⁰). PKC is highly enriched in brain and plays a major role in regulating presynaptic and postsynaptic aspects of neurotransmission.^{42,71,72} PKC is one of the major intracellular mediators of signals generated upon external stimulation of cells via a variety of neurotransmitter receptor subtypes that induce the hydrolysis of membrane phospholipids. PKC is now known to exist as a family of closely related subspecies, has a heterogeneous distribution in brain (with particularly high levels in presynaptic nerve terminals), and plays a major role in the regulation of neuronal excitability, neurotransmitter release, and long-term alterations in gene expression and plasticity.^{42,71,72}

Recent evidence accumulating from various laboratories has demonstrated that lithium exerts significant effects on PKC in a number of cell systems including the brain.^{10,28,73} The preponderance of the currently available data suggests that chronic lithium exposure results in an attenuation of phorbol ester-mediated responses, which may be accompanied by a down-regulation of PKC isozymes (reviewed in Jope and Williams²⁸ and Manji et al.^{10,73}). Activation of PKC is now known to facilitate the release of a number of neurotransmitters, and biochemical studies have revealed that chronic (3-week) lithium at therapeutic levels attenuates PKC-induced [³H]5-HT release in hippocampus.⁷⁴ Although the precise mechanisms by which PKC activation facilitates neurotransmitter release remain to be fully elucidated, it has been postulated that the phosphorylation of myristoylated alanine-rich C kinase substrate (MARCKS) and growth-associated pro-

Figure 4. Computer-Generated Pseudocolor Images of PKC Distribution in Hippocampi From Representative Control (A) and Lithium-Treated (B) Rats*

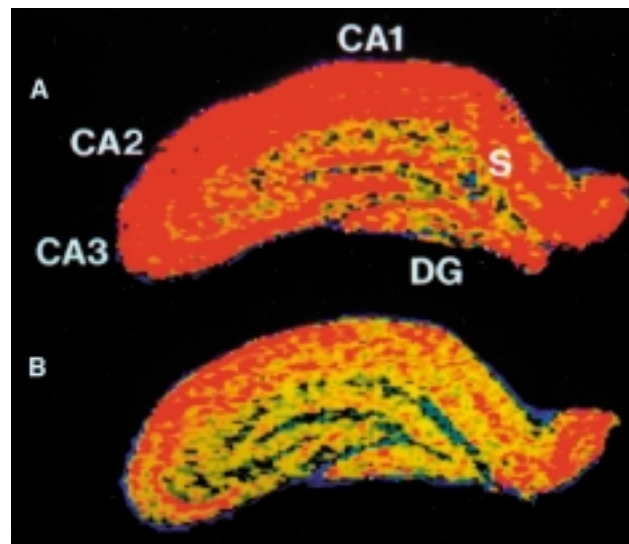

*Reproduced with permission from Manji et al.⁷⁸ Male Sprague-Dawley rats were fed Li₂CO₃-supplemented chow (0.165% by weight) for 5 weeks (serum lithium concentration, 0.82 ± 0.07 mM). Following decapitation, brains were rapidly frozen and cryosections cut at 20 μm onto gelatin-coated slides. Sections were incubated with [³H]PDBu (2.5 nM, 20 Ci/mmol) according to previously described methods, and autoradiograms produced by simultaneously exposing LKB Ultrofilm to brain sections and radioactive standards. For each coronal section through the dorsal hippocampus, regions of interest (ROIs) were produced without knowledge of the experimental group around the subiculum (S), CA1, CA3, and dentate gyrus (DG) fields. Measurements of multiple coronal brain image slices from each rat produced an overall mean [³H]PDBu binding for each ROI in that rat. These means for each ROI were compared between groups with 1-way ANOVAs, with post hoc Scheffé analysis. Image analysis revealed significant 30% decreases in [³H]PDBu binding in the CA1 region (F = 5.83, df = 1,14; p < .05, 1-way analysis of variance) and subiculum (F = 5.50, df = 1,14; p < .05, 1-way analysis of variance) in the lithium-treated group compared with the control group. Smaller, nonsignificant decreases in [³H]PDBu binding were also observed in the CA3 region and dentate gyrus.

tein (GAP-43) by PKC plays a key role in facilitating neurotransmitter release.^{75,76} In this context, it is noteworthy that seminal studies by Lenox and associates (this volume)⁷⁷ have demonstrated that the levels of MARCKS, a protein implicated in synaptic transmission, were significantly reduced after chronic lithium exposure.

Using quantitative autoradiographic techniques, it has been demonstrated that chronic (5-week) lithium administration results in a significant decrease in membrane-associated PKC in several hippocampal structures, most notably the subiculum and CA1 region, in the absence of any significant changes in the various other cortical and subcortical structures examined⁷⁸ (Figure 4). Furthermore, immunoblotting using monoclonal anti-PKC antibodies has revealed an isozyme-specific decrease in PKC α and ε (which have been particularly implicated in facilitating neurotransmitter release), in the absence of significant

alterations in PKC β , PKC γ , PKC δ , or PKC ζ . The mechanisms by which lithium produces the isozyme-selective decreases in the immunolabeling of PKC α and PKC ϵ are presently unclear.⁷³ Although PKC subspecies exhibit subtle differences in their enzymatic properties, ligand binding, and substrate specificity *in vitro*, the isoforms exhibit different tissue- and cell type-specific expression patterns *in vitro*, and they also differ in their susceptibility to degradation. Do these effects of lithium on PKC isozymes have any clinical relevance? The decreases in the levels of PKC α and PKC ϵ following chronic lithium may represent 1 mechanism by which chronic lithium administration attenuates the release of catecholamines, and, along with its effects on receptor/G protein coupling (*vide infra*), may be relevant to lithium's protective effects against spontaneous-, stress-, and pharmacologic (e.g., stimulant)-induced manic episodes. Indeed, given the key role(s) of these PKC isozymes in the regulation of neuronal excitability and neurotransmitter release, the possibility that inhibition of PKC isozymes represents the biochemical effect most therapeutically relevant for lithium's antimanic effects is a heuristic and testable hypothesis (discussed in more detail below). In the absence of suitable animal models for the major psychiatric disorders, a major problem inherent in neuropharmacologic research is the difficulty in precisely ascribing therapeutic relevance to any observed biochemical finding.

One approach that can be utilized is to identify common biochemical targets that are modified by drugs belonging to the same therapeutic class (e.g., antimanic agents) but possessing distinct chemical structures (e.g., lithium and divalproex, the only 2 drugs approved by the Food and Drug Administration [FDA] for the treatment of bipolar disorder) when administered in a "therapeutically relevant" paradigm. These are 2 structurally highly dissimilar, but therapeutically efficacious agents; although they likely do not exert their therapeutic effects by precisely the same mechanisms, identifying the biochemical targets that are regulated in concert by these 2 agents, when administered in a therapeutically relevant paradigm, may provide important clues about molecular mechanisms underlying mood stabilization in the brain. In view of lithium's significant effects on PKC outlined above, we have investigated the effects of valproate on various aspects of PKC functioning. We have found that the structurally highly dissimilar agent, valproate, produces strikingly similar effects on the PKC signaling pathway as does lithium.^{20,73,79} Interestingly, chronic lithium and valproate appear to regulate PKC isozymes by distinct mechanisms, with effects of valproate appearing to be largely independent of *myo*-inositol. This biochemical observation is consistent with the clinical observations that some patients show preferential response to one agent or the other and that one often observes additive therapeutic effects in patients when the 2 agents are coadministered.

PKC INHIBITORS IN THE TREATMENT OF ACUTE MANIA

In view of the pivotal role of the PKC signaling pathway in the regulation of neuronal excitability, neurotransmitter release, and long-term synaptic events,^{42,71,72,80} we⁸¹ have postulated that the attenuation of PKC activity may play a major role in the therapeutic effects of the only 2 drugs approved by the FDA for the treatment of mania. There is thus a clear need to investigate the efficacy of PKC inhibitors in the treatment of mania. There is currently only 1 relatively selective PKC inhibitor available for human use—tamoxifen. Tamoxifen, a synthetic nonsteroidal antiestrogen, has been widely used in the treatment of breast cancer.^{82,83} A number of its effects are due to estrogen receptor antagonism,⁸² but it has become clear in recent years that it is also a potent PKC inhibitor at therapeutically relevant concentrations.⁸⁴ We have therefore initiated a pilot study investigating the efficacy of tamoxifen in the treatment of acute mania.⁸⁵ Clearly, these results have to be considered preliminary due to the small sample size thus far. Nevertheless, the significant (and in some cases rapid and striking) results we observed do suggest that tamoxifen possesses antimanic properties.⁸⁵ In view of the preliminary data suggesting the involvement of the PKC signaling system in the pathophysiology of bipolar disorder,^{86,87} these results suggest that PKC inhibitors may be very useful agents in the treatment of bipolar disorder. Larger, double-blind placebo-controlled studies of tamoxifen and of novel selective PKC inhibitors in the treatment of mania are clearly warranted.

LITHIUM AND G PROTEINS

As discussed already, abundant experimental evidence has shown that lithium attenuates receptor-mediated adenylyl cyclase activity and phosphoinositide turnover in rodents and in man, in the absence of consistent changes in the density of the receptors themselves.^{10,88} Although the lithium ion (at therapeutic concentrations) does not directly affect G protein function, there is considerable evidence that chronic lithium administration affects G protein function.^{10,88,89} Although some studies have reported modest changes in the levels of G protein subunits, the preponderance of the data suggests that chronic lithium does not modify G protein levels *per se* (reviewed in Lenox and Manji²¹), but clearly modifies G protein function (Table 1).

One tool that has been utilized to investigate the effects of chronic lithium on G protein function is pertussis toxin. Pertussis toxin is an invaluable tool for the study of G proteins because it catalyzes the transfer of an ADP-ribose moiety from nicotinamide adenine dinucleotide (NAD, an endogenous compound present in every cell) onto certain G proteins. The use of subunit-selective antisera is clearly the method of choice for quantitating G pro-

Table 1. Evidence for the Effects of Lithium on G Proteins*

Attenuation of receptor-stimulated adenylyl cyclase activity
Attenuation of receptor-mediated and GTP γ S-mediated phosphoinositide turnover
Attenuation of agonist-induced [3 H]GTP binding
Reversal of the effects of lithium by increasing GTP
Increase in lymphocyte and rat brain β -adrenergic receptor K_L/K_H ratio
Increase in pertussis toxin-catalyzed [32 P]ADP-ribosylation in platelets and in rat brain
Reduction in $G\alpha_s$, $G\alpha_{i1}$, $G\alpha_{i2}$ mRNA in rat cortex

*Reproduced with permission from Manji et al., 1996.⁷³

tein subunit levels. However, since these antisera recognize both the dissociated active α subunits and the corresponding undissociated, inactive heterotrimeric $\alpha\beta\gamma$ complex, they do not, when utilized alone, provide information about conformational changes occurring in the absence of quantitative changes. For this reason, pertussis toxin can be an invaluable tool for the functional and structural aspects of various G proteins. By using [32 P]NAD $^+$ and determining the transfer of its [32 P]ADP-ribose moiety to membrane components, it is possible to obtain information about functional aspects of the G protein. The functional aspect that can be studied using [32 P]ADP-ribosylation of membrane components is possible because pertussis toxin selectively catalyzes the ADP-ribosylation of a given conformational state (dissociated/undissociated) of the G proteins. Thus, altered susceptibility of the G proteins to toxin-catalyzed ADP ribosylation has been shown to result from an altered conformational state and to correlate with alterations in relaying molecular signals from extracellular receptors to intracellular effectors.^{10,90}

In contrast to the negligible effects on the levels of G protein subunits, chronic lithium has been shown to produce a significant increase in pertussis toxin-catalyzed [32 P]ADP-ribosylation both in rat brain and in platelets of subjects undergoing lithium treatment.^{73,91,92} Since pertussis toxin selectively catalyzes the ADP-ribosylation of the undissociated, inactive $\alpha\beta\gamma$ heterotrimeric form of G_i ,⁹⁰ these results suggest that lithium inactivates G_i via a stabilization of the inactive conformation (*vide supra*). Overall, the data strongly argue for an effect of chronic lithium on the signal-transducing G proteins in both humans and rodents. Interestingly, for both G_s and G_i , lithium's major effects appear to be a stabilization of the heterotrimeric, undissociated ($\alpha\beta\gamma$) conformation of the G protein.

Do lithium's effects on signal-transducing G proteins have any relevance to its putative antisuicidal effect? It should be articulated that any attempts to link specific biochemical effects to a highly complex behavior such as suicide must clearly be considered highly speculative. Nevertheless, the signal-transducing G proteins represent biochemical targets that are well placed to regulate the functional balance between interacting neurotransmitter systems, thereby making them attractive candidates for

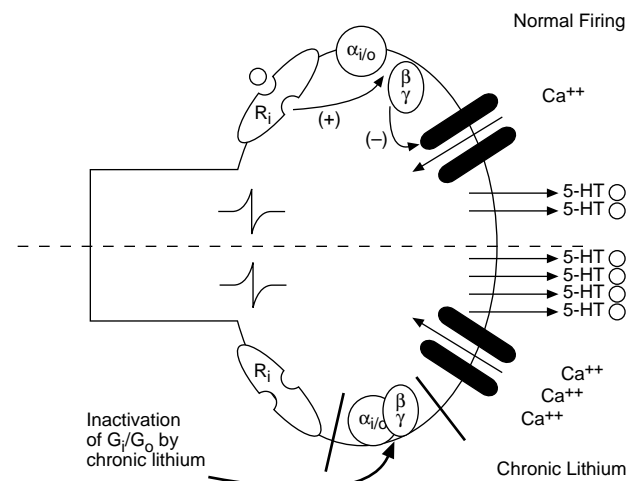
Figure 5. Regulation of Serotonin Release by Nerve Terminal Autoreceptors and Heteroreceptors: Effects of Chronic Lithium*

*Inhibitory autoreceptors (generally 5-HT_{1B/D}) and heteroreceptors (e.g., α_2 -adrenergic receptors) are present on serotonin nerve terminals and regulate serotonin release. When activated, these receptors activate certain G proteins (G_i and G_o); these G proteins dissociate into α and $\beta\gamma$ subunits. The activated $\beta\gamma$ subunits of G_s /G $_o$ inhibit certain voltage-gated Ca $^{++}$ channels, thereby inhibiting serotonin release. Chronic lithium uncouples the receptors from the G proteins and may maintain the G protein in its inactive, undissociated $\alpha\beta\gamma$ heterotrimeric conformation. The net effect of this is to facilitate the amount of serotonin released per nerve impulse. Abbreviations: R_i = inhibitory receptor, $\alpha_{i/o}$ = α subunit of G proteins, G_i and G_o , $\beta\gamma$ = G protein $\beta\gamma$ subunits, 5-HT = serotonin.

mediating complex behaviors. Although our understanding about the neurobiology of suicide is clearly in its infancy, the neurotransmitter serotonin has been implicated in several studies, leading to the hypothesis that low serotonergic activity is associated with increased suicide risk (see review by Mann,⁹³ this volume). In this context, it is noteworthy that lithium, via its effects on G_s /G $_o$, has been demonstrated to desensitize presynaptic nerve terminal autoreceptors regulating serotonin release^{89,94} (see Figure 5). This action would be compatible with increased serotonin release in critical neuronal circuits, effects that may underlie the putative antisuicidal effects of lithium.

Although also clearly highly speculative, it is also plausible that disruption of signaling pathways may play a role in the purported increase in suicidality observed with cholesterol-lowering agents. Recent evidence has suggested that pharmacologic lowering of cholesterol is associated with increased nonillness mortality (with suicide as a major contributor).⁹⁵ The possibility that signal transduction pathways underlie some of the behavioral manifestations of cholesterol-lowering agents is suggested by the observation that the activity of many heterotrimeric G proteins may be modulated by isoprenylation.^{96,97} Protein isoprenylation is a posttranslational modification in which a farnesyl or geranyl isoprenoid, derived from the mevalonate pathway, is attached to a carboxy-terminal cysteine

Figure 6. Membrane Attachment of G Protein Subunits: Potential Targets for the Behavioral Effects of Cholesterol-Lowering Agents*

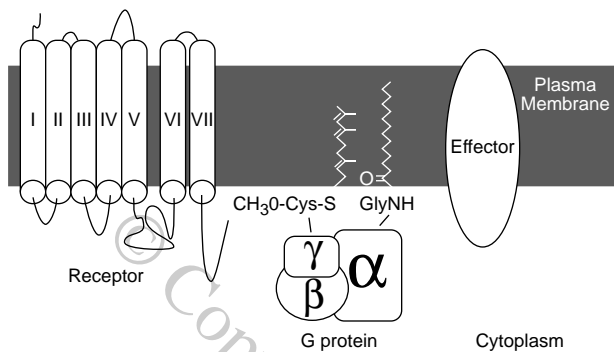

*The figure depicts the mechanisms by which G protein α and γ subunits are attached to the plasma membrane, thereby allowing for appropriate signal throughput from receptors to effectors. The lipid modifications of the G protein subunits may be impaired by the cholesterol-lowering agent lovastatin, biochemical effects which may underlie (in part) the reported behavioral effects of these agents.

residue.⁹⁸ The physiologic importance of these posttranslational modifications becomes apparent when one recognizes that the action of $G\alpha_s$ on adenylyl cyclase is dependent on the interaction of the subunit with the cell membrane,^{99,100} effects that are related to the lipid modifications of the G protein subunits.¹⁰¹ Notably, the γ subunit of the heterotrimeric G proteins is prenylated.¹⁰² Most pertinent to the present discussion, the cholesterol-lowering drug lovastatin, which is a competitive inhibitor of hydroxy-methylglutaryl-coenzyme A (HMG-CoA) reductase, suppresses mevalonate synthesis and protein prenylation (see Figure 6).^{99,103} The potential clinical relevance of these biochemical effects is suggested by the observations that lovastatin has been demonstrated to decrease the membranous levels of $G\alpha_s$,¹⁰⁴ to reduce corresponding adenylyl cyclase activity,¹⁰⁴ and to reduce cAMP-mediated gene expression¹⁰⁵ in cultured cells. Interestingly, lovastatin has also recently been demonstrated to have a suppressant effect on PKC activation, effects which may be attributable to an impairment of cytosol to membrane translocation of PKC.¹⁰⁶ Thus, at least in in vitro cell culture models, the cholesterol-lowering agent lovastatin has been demonstrated to disrupt the membrane attachment of critical signal molecules. It is thus quite plausible that the disruption of cellular signaling may, in susceptible individuals, be associated with adverse behavioral sequelae, and is worthy of further study.

DO ALL PUTATIVE MOOD-STABILIZING AGENTS EXERT EFFECTS ON THE PKC SIGNALING PATHWAY?

In contrast to the effects observed with lithium and valproate described above, we have found that carba-

mazepine, a clinically efficacious antimanic and mood-stabilizing agent, has very modest effects on the PKC signaling pathway. We have thus investigated the effects of carbamazepine on another major transmembrane signaling system, the cyclic AMP (cAMP) generating pathway. The cAMP generating system also plays a major role in the regulation of neuronal excitability, and has been postulated to play a role in the pathophysiology of both seizure disorders¹⁰⁷⁻¹¹¹ and bipolar disorder.¹¹² We have found that carbamazepine, at therapeutically relevant concentrations, inhibits both basal adenylyl cyclase and forskolin (FSK)-stimulated cAMP accumulation in C6 glioma cells.¹¹³ Within the clinical therapeutic range (~50 μ M), carbamazepine inhibited basal cAMP levels by 10% to 20%, and FSK-stimulated cAMP production by 40% to 60%. Together, these data indicate that carbamazepine is more effective in inhibiting the activated adenylyl cyclase system, although the possibility of "floor effects" (that is, an inability to lower basal cAMP levels beyond certain levels in this system) cannot be ruled out.

To further characterize the mechanism(s) by which carbamazepine attenuates basal and FSK-stimulated cAMP, we investigated the inhibitory G protein, G_i . Thus, a carbamazepine-induced activation of G_i might be postulated to underlie the decreases in basal and FSK-stimulated cAMP that we have observed. To further characterize the site at which carbamazepine exerts its inhibitory effects, we purified adenylyl cyclases from rat cerebral cortex using a FSK affinity purification column. We found that similar to the situation observed in intact C6 cells and in C6 cell membranes, carbamazepine inhibited both basal and FSK-stimulated activity of purified adenylyl cyclase (see Table 2).¹¹³ Taken together, the data suggest that carbamazepine inhibits cAMP production by acting directly on adenylyl cyclase and/or through factor(s) that are tightly associated with and co-purify with adenylyl cyclase. In view of the major role of the cAMP system in the regulation of neuronal excitability and neurotransmitter release, and the evidence for this system in the pathophysiology of seizure disorders and bipolar disorder, these effects may play a role in the therapeutic effects of carbamazepine.

EFFECTS OF MOOD STABILIZERS ON TRANSCRIPTION FACTORS AND GENE EXPRESSION

In recent years, it has become increasingly appreciated that any relevant biochemical models proposed for the effects of many psychotropic drugs (including mood stabilizers, antidepressants, and antipsychotics) must attempt to account for their special temporal clinical profile—in particular that the therapeutic effects require a lag period for onset of action and are generally not immediately reversed upon discontinuation.^{10,114} Patterns of effects requiring such prolonged administration of the drug suggest alterations at

Table 2. Effects of Carbamazepine on Adenylyl Cyclase Activity*

Basal activity	↓
Forskolin stimulated	↓
Cholera toxin stimulated	↓
Phosphodiesterases	0
Purified adenylyl cyclase activity	↓
CREB phosphorylation	↓

*Reproduced with permission from Manji et al., 1996.⁷³

the genomic level.^{10,114} To investigate the putative effects of mood stabilizers on gene expression, we have initially examined their effects on the DNA binding activity of transcription factors, especially the AP-1 family of transcription factors. Activator protein-1 (AP-1) is a collection of homodimeric and heterodimeric complexes composed of products from 2 transcription factor families, Fos and Jun. These products bind to a common DNA site (known as the 12-*o*-tetradecanoyl-phorbol 13-acetate [TPA] response element) in the regulatory domain of the gene and activate gene transcription in response to PKC activators, growth factors, cytokines, and other agents (including neurotransmitters).^{115,116} Induction of *c-fos* is rapid and transient; Fos protein reaches its maximal levels within 30 minutes, and decreases to low levels within 1 to 2 hours.¹¹⁶ Induction of *c-jun* is longer lasting and varies from a few hours to several days in a cell-type and stimulus-dependent manner.¹¹⁶ The *c-jun* gene is subject to positive autoregulation through an AP-1 binding site in its promoter. The genes known to be regulated by the AP-1 family of transcription factors in the brain include genes for various neuropeptides, neurotrophins, receptors, transcription factors, enzymes involved in neurotransmitter biosynthesis, and proteins that bind to cytoskeletal elements.¹¹⁶

In recent years, several independent laboratories have demonstrated that lithium, at therapeutically relevant concentrations, regulates AP-1 DNA binding activity.¹¹⁷⁻¹²³ The effects of lithium and valproate on DNA binding activity of AP-1 have been examined using methods verified by both competition assay with cold and mutant TPA response element (TRE) oligos and supershift assay with antibodies against AP-1 transcription factors.¹²¹⁻¹²³ We have found that both lithium and valproate, at therapeutically relevant concentrations, produce a time- and concentration-dependent increase in the DNA-binding of TRE to AP-1 transcription in rat brain *ex vivo* and in cultured human neuroblastoma cells factors.¹²¹⁻¹²⁴ Studies have further confirmed that these effects on AP-1 DNA binding activity do, in fact, translate into changes at the gene expression level. Effects of lithium on gene expression were first studied in cells transiently transfected with the pGL2-control vector. The reporter gene, luciferase, in the pGL2-control vector is driven by an SV40 promoter, which has 2 characterized AP-1 sites. Using this reporter gene transfection system, we attempted to further verify the role of AP-1 sites in

mediating the effects of lithium and valproate on gene expression by eliminating the AP-1 sites by mutagenesis. Lithium and valproate in a time- and concentration-dependent manner increased the expression of a luciferase reporter gene driven by an SV40 promoter that contains TREs.^{121-123,125} Furthermore, mutations in the TRE sites of the reporter gene promoter markedly attenuated these effects. These data indicate that lithium and valproate may stimulate gene expression (at least in part) through the AP-1 transcription factor pathway, effects that may play an important role in its long-term clinical actions.

In order to ascribe any potential therapeutic relevance to the observed biochemical findings, it is obviously necessary to demonstrate that they do, in fact, also occur in critical regions of the CNS *in vivo*. It is well established that the expression of tyrosine hydroxylase (TH) is mediated in large part by the AP-1 family of transcription factors.¹²⁶ We therefore investigated the effects of acute and chronic lithium on the levels of TH in 3 brain areas that have been implicated in the pathophysiology of mood disorders—frontal cortex, hippocampus, and striatum.^{1,127-130} Chronic lithium significantly increased the levels of TH in all 3 brain areas as well as in human neuroblastoma SY5Y cells (Figure 7).¹³¹ Future *in situ* hybridization studies or immunohistochemistry studies are clearly needed to determine if lithium also increases the expression of TH areas of brain known to contain the cell bodies of the major noradrenergic and dopaminergic systems, namely the locus ceruleus, ventral tegmental area, and substantia nigra. Alterations in the functioning of the catecholaminergic system have been postulated in the pathophysiology and treatment of mood disorders for decades^{1,132}; the potential role of these changes in TH in mediating lithium's putative antisuicidal effects remains to be elucidated. The results clearly show that, in addition to increasing AP-1 DNA binding activity and the expression of the luciferase reporter gene *in vitro*, chronic lithium increases the TH levels in areas of rat brain *ex vivo*. These effects are compatible with an effect on the DNA-binding of TRE to the AP-1 family of transcription factors and have the potential to regulate patterns of gene expression in critical neuronal circuits.^{133,134} The precise mechanisms by which lithium regulates AP-1 DNA binding activity remains to be fully delineated, but may involve effects on mitogen-activated protein kinases. In addition, it is noteworthy that lithium, at clinically relevant concentrations, has recently been demonstrated to inhibit the activity of glycogen synthase kinase-3 β (GSK-3 β).¹³⁵⁻¹³⁷ GSK-3 β is known to phosphorylate *c-jun* at 3 sites adjacent to the DNA binding domain, thereby reducing TRE binding.^{134,137} Interestingly, valproate, at therapeutically relevant concentrations, has also recently been demonstrated to inhibit the activity of GSK α and GSK β ¹³⁸; the role of GSK-3 β in regulating changes in CNS gene expression by mood-stabilizing agents is thus a very exciting new area of research (see Figure 8).

Figure 7. Effects of Lithium on Tyrosine Hydroxylase (TH) Levels in Areas of Rat Brain and in Human Neuroblastoma SH-SY5Y Cells†

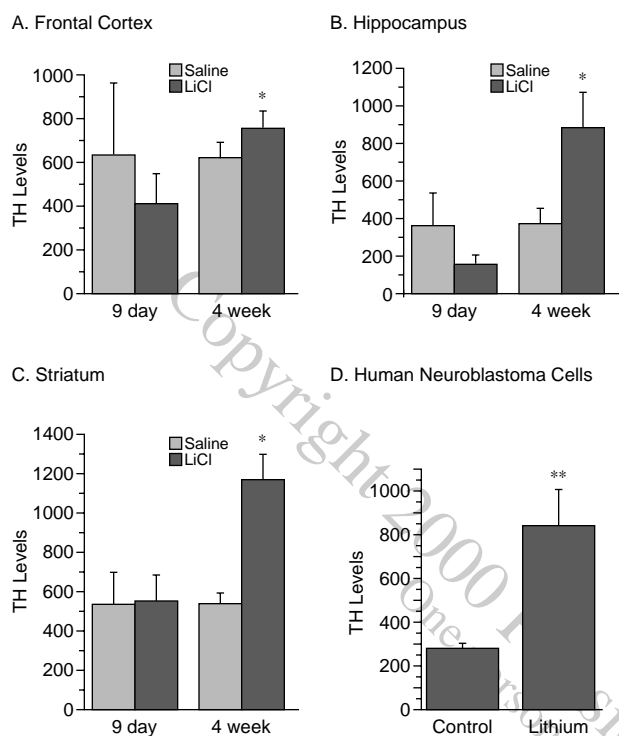

†Reproduced, with modifications and permission from Chen et al.¹³¹ Rats were treated with lithium and saline for 9 days or 4 weeks. Frontal cortex (A), hippocampus (B), and striatum (C) samples were subjected to sodium dodecyl sulfate–polyacrylamide gel electrophoresis and immunoblotting of TH. Four weeks of lithium treatment resulted in increases in TH levels in frontal cortex (approximately 2%) hippocampus (approximately 140%), and striatum (approximately 120%). **p* < .05 compared with saline-treated rats. Human SH-SY5Y neuroblastoma cells (D) were incubated with lithium (1 mM), and immunoblotting of TH was conducted in whole-cell lysates. Incubation with lithium resulted in significant increases in the levels of TH in these cells. ***p* < .05 compared with control.

CONCLUDING REMARKS

We clearly still have much to learn about the mechanisms of action of mood-stabilizing agents, but the rate of progress in recent years has been exciting indeed. The behavioral and physiologic manifestations of the recurrent mood disorders are complex and are mediated by a network of interconnected neurotransmitter pathways; thus, regulation of signal transduction within critical regions of the brain remains an attractive target for psychopharmacologic interventions. Current studies of the long-term treatment-induced changes in the phosphoinositide and PKC signaling pathways, GSK-3 β , and gene expression regulation are most promising avenues for investigation.

The recent advances in the identification of signal transduction pathways as targets for mood-stabilizing agents also have the potential to lead to the development

Figure 8. Regulation of AP-1 DNA Binding Activity by Protein Kinases: Therapeutic Implications*

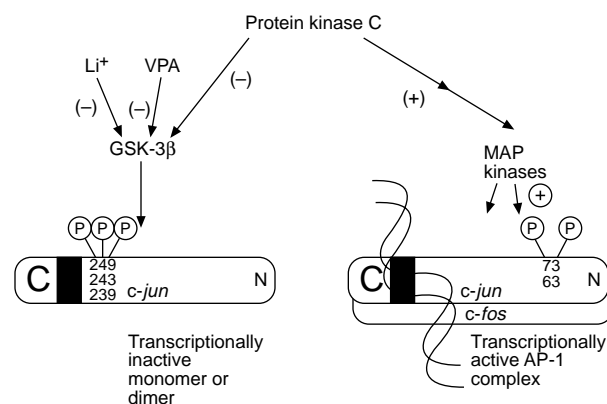

*Protein kinase C isozymes have the potential to regulate AP-1 DNA binding activity in a number of ways. PKC isozymes activate certain mitogen-activated protein (MAP) kinases, which phosphorylate *c-jun*, thereby enhancing the formation of the active AP-1 complex. Glycogen synthase kinase 3 β (GSK-3 β) is known to phosphorylate *c-jun* at sites adjacent to the DNA binding domain, thereby reducing AP-1 binding; interestingly both lithium and valproate (VPA) at therapeutically relevant concentrations inhibit the activity of GSK-3 β . Thus, lithium and VPA may increase AP-1 DNA binding activity (at least in part) by inhibiting GSK-3 β , thereby removing its tonic inhibitory effects on AP-1.

of truly novel effective pharmacotherapies for mood disorders. It is becoming increasingly clear that for many patients new drugs simply mimicking the “traditional” drugs that directly or indirectly alter neurotransmitter levels and those that bind to cell surface receptors may be of limited benefit. This is because such strategies implicitly assume that the target receptor(s) is functionally intact, and that altered synaptic activity will thus be transduced to modify the postsynaptic “throughput” of the system. However, improved therapeutics for refractory patients may only be obtained by the direct targeting of postreceptor sites. Although clearly more complex than the development of receptor-specific drugs, it may be possible to design novel agents to selectively affect second messenger systems because they are quite heterogeneous at the molecular and cellular level, are linked to receptors in a variety of ways, and are expressed in different stoichiometries in different cell types. Additionally, since signal transduction pathways display certain unique characteristics depending on their activity state (e.g., rate of guanine nucleotide exchange, G protein conformational states, GTP hydrolysis, interaction with different RGS [regulators of G protein signaling] proteins, cytosol-to-membrane translocation of PKC isozymes and receptor kinases), they offer built-in targets for relative specificity of action, depending on the “set-point” of the substrate. In sum, the rapid technological advances in both biochemistry and molecular biology have greatly enhanced our ability to understand the complexities of the regulation of neuronal function; these advances hold much promise for the development of novel

improved therapeutics for mood disorders, as well as for our understanding of the pathophysiology of these life-threatening illnesses.

Drug names: carbamazepine (Tegretol and others), divalproex sodium (Depakote), lovastatin (Mevacor), tamoxifen (Nolvadex).

REFERENCES

- Goodwin FK, Jamison KR. Manic-Depressive Illness. New York, NY: Oxford University Press; 1990
- Simpson SG, Jamison KR. The risk of suicide in patients with bipolar disorders. *J Clin Psychiatry* 1999;60(suppl 2):53-56
- Greenberg PE, Stiglin LE, Finkelstein SN, et al. The economic burden of depression in 1990. *J Clin Psychiatry* 1993;54:405-419
- Wyatt RJ, Henter I. An economic evaluation of manic-depressive illness. *Soc Psychiatry Psychiatr Epidemiol* 1995;30:213-219
- Baldessarini RJ, Tondo L. Effects of lithium treatment and its discontinuation in bipolar disorder: overview of recent research findings from the International Consortium for Bipolar Disorders Research. *American Society of Clinical Psychopharmacology Progress Notes*, Fall 1997;8(2):21-26
- Manji HK, Lenox RH. Lithium: a unique cation in biology and medicine. *Neuropsychopharmacology* 1998;19:161-240
- Baldessarini RJ, Tondo L, Hennen J. Effects of lithium treatment and its discontinuation on suicidal behavior in bipolar manic-depressive disorders. *J Clin Psychiatry* 1999;60(suppl 2):77-84
- Müller-Oerlinghausen B, Ahrens B, Grof E, et al. The effect of long-term lithium treatment on the mortality of patients with manic-depressive and schizoaffective illness. *Acta Psychiatr Scand* 1992;86:218-222
- Bunney WE, Garland-Bunney BL. Mechanisms of action of lithium in affective illness: basic and clinical implications. In: Meltzer HY, ed. *Psychopharmacology: The Third Generation of Progress*. New York, NY: Raven Press; 1987:553-565
- Manji HK, Potter WZ, Lenox RH. Signal transduction pathways: molecular targets for lithium's actions. *Arch Gen Psychiatry* 1995;52:531-543
- Kramlinger KG, Post RM. The addition of lithium to carbamazepine: antidepressant efficacy in treatment-resistant mania. *Arch Gen Psychiatry* 1989;46:794-800
- Chou JC. Recent advances in treatment of acute mania. *J Clin Psychopharmacol* 1991;11(1):3-21
- Post RM, Ballenger JC, Uhde TW, et al. Efficacy of carbamazepine in manic-depressive illness: implications for underlying mechanisms. In: Post RM, Ballenger JC, eds. *Neurobiology of Mood Disorders*. Baltimore, Md: Williams & Wilkins; 1984:777-816
- McElroy SL, Keck PE Jr, Pope HG Jr, et al. Valproate in the treatment of bipolar disorder: literature review and clinical guidelines. *J Clin Psychopharmacol* 1992;12:42S-52S
- Bowden CL, Brugger AM, Swann AC, et al. Efficacy of divalproex vs lithium and placebo in the treatment of mania. *JAMA* 1994;271:918-924
- Swann AC, Bowden CL, Morris D, et al. Depression during mania: treatment response to lithium or divalproex. *Arch Gen Psychiatry* 1997;54:37-42
- Keck PE, McElroy SL. Outcome in the pharmacologic treatment of bipolar disorder. *J Clin Psychopharmacol* 1996;16(suppl 1):15S-23S
- Bowden CL. Lithium comparison to valproate and carbamazepine. Presented at the 20th Congress of the Collegium Internationale Neuropsychopharmacologicum; June 23-27, 1996; Melbourne, Australia
- Post RM, Weiss SR, Clark M, et al. Lithium, carbamazepine and valproate in affective illness: biochemical and neurobiological mechanisms. In: Manji HK, Bowden CL, Belmaker RH, eds. *Mechanisms of Antibipolar Treatments*. American Psychiatric Press. In press
- Manji HK, Chen G, Hsiao JK, et al. Regulation of signal transduction pathways by mood stabilizing agents: implications for the pathophysiology and treatment of bipolar affective disorder. In: Manji HK, Bowden CL, Belmaker RH, eds. *Mechanisms of Antibipolar Treatments*. American Psychiatric Press. In press
- Lenox RH, Manji HK. Lithium. In: Nemeroff CB, Schatzberg AF, eds. *American Psychiatric Press Textbook of Psychopharmacology*. Washington, DC: American Psychiatric Press; 1995:303-350
- Post RM, Weiss SR, Chuang DM. Mechanisms of action of anti-convulsants in affective disorders: comparisons with lithium. *J Clin Psychopharmacol* 1992;12:42S-52S
- Rogawski MA, Porter RJ. Antiepileptic drugs: pharmacological mechanisms and clinical efficacy with consideration of promising development stage compounds. *Pharmacol Rev* 1990;42:223-286
- Manji HK. G proteins: implications for psychiatry. *Am J Psychiatry* 1992;149:746-760
- Bourne HR, Nicoll R. Molecular machines integrate coincident synaptic signals. *Cell* 1993;72(suppl):65-75
- Ross EM. Signal sorting and amplification through G protein-coupled receptors. *Neuron* 1989;3:141-152
- Taylor CW. The role of G proteins in transmembrane signaling. *Biochem J* 1990;272:1-13
- Jope RS, Williams MB. Lithium and brain signal transduction systems. *Biochem Pharmacol* 1994;77:429-441
- Baraban JM, Worley PF, Synder SH. Second messenger systems and psychoactive drug action: focus on the phosphoinositide system and lithium. *Am J Psychiatry* 1989;146:1251-1260
- Chuang DM. Neurotransmitter receptors and phosphoinositide turnover. *Annu Rev Pharmacol Toxicol* 1989;29:71-110
- Catt KJ, Balla T. Phosphoinositide metabolism and hormone action. *Annu Rev Med* 1989;40:487-509
- Berridge MJ, Irvine RF. Inositol phosphates and cell signalling. *Nature* 1989;341:197-205
- Rana RS, Hokin LE. Role of phosphoinositides in transmembrane signaling. *Physiol Rev* 1990;70:115-164
- Fisher SK, Heacock AM, Agranoff BW. Inositol lipids and signal transduction in the nervous system: an update. *J Neurochem* 1992;58:18-38
- Allison JH, Stewart MA. Reduced brain inositol in lithium treated rats. *Nature [New Biol]* 1971;233:267-268
- Hallcher LM, Sherman WR. The effects of lithium ion and other agents on the activity of myo-inositol-1-phosphatase from bovine brain. *J Biol Chem* 1980;255:10896-10901
- Nahorski SR, Ragan CI, Challiss RAJ. Lithium and the phosphoinositide cycle: an example of uncompetitive inhibition and its pharmacological consequences. *Trends Pharmacol Sci* 1991;12:297-303
- Nahorski SR, Jenkinson S, Challiss RA. Disruption of phosphoinositide signalling by lithium. *Biochem Soc Trans* 1992;20:430-434
- Berridge MJ, Downes CP, Hanley MR. Lithium amplifies agonist-dependent phosphatidylinositol responses in brain and salivary glands. *Biochem J* 1982;206:587-595
- Berridge MJ, Downes CP, Hanley MR. Neural and developmental actions of lithium: a unifying hypothesis. *Cell* 1989;59:411-419
- Sherman WR. Lithium and the phosphoinositide signalling system. In: Birch NJ, ed. *Lithium and the Cell*. London, England: Academic Press; 1991:121-157
- Nishizuka Y. Protein kinase C and lipid signalling for sustained cellular responses. *FASEB J* 1995;9:484-496
- Godfrey PP, McClue SJ, White AM, et al. Potentiation by lithium of CMP-phosphatidate formation in carbachol-stimulated rat cerebral-cortical slices and its reversal by myo-inositol. *Biochem J* 1989;258:621-624
- Pontzer NJ, Crews FT. Desensitization of muscarinic stimulated hippocampal cell firing is related to phosphoinositide hydrolysis and inhibited by lithium. *J Pharmacol Exp Ther* 1990;253:921-929
- Kofman O, Belmaker RH. Intracerebroventricular myo-inositol antagonizes lithium-induced suppression of rearing behaviour in rats. *Brain Res* 1990;534:345-347
- Kofman O, Belmaker RH. Biochemical, behavioral and clinical studies of the role of inositol in lithium treatment and depression. *Biol Psychiatry* 1993;34:839-852
- Trickelbank MD, Singh L, Jackson A, et al. Evidence that a proconvulsant action of lithium is mediated by inhibition of myo-inositol phosphatase in mouse brain. *Brain Res* 1991;558:145-148
- Manji HK, Bersudsky Y, Chen G, et al. Modulation of PKC isozymes and substrates by lithium: the role of myo-inositol. *Neuropsychopharmacology* 1996;15:370-382
- Faedda GL, Baldessarini RJ, Tohen M, et al. Episode sequence in bipolar disorder and response to lithium treatment. *Am J Psychiatry* 1991;148:1237-1239
- Goodnick PJ, Fieve RR, Peselow E, et al. General behavior inventory: measurement of subclinical changes during depression and lithium prophylaxis. *Acta Psychiatr Scand* 1986;73:529-532
- Himmelhoch JM, Garfinkel ME. Mixed mania: diagnosis and treatment. *Psychopharmacol Bull* 1986;22:613-620
- Swann AC, Secunda SK, Katz MM, et al. Lithium treatment of mania:

- clinical characteristics, specificity of symptom change, and outcome. *Psychiatry Res* 1986;18:127–141
53. Gurling H, Smyth C, Kalsi G, et al. Linkage findings in bipolar disorder. *Nature Genet* 1995;10:8–9
 54. Gelernter J. Genetics of bipolar affective disorder: time for another reinvention? *Am J Hum Genet* 1995;56(6):1262–1266
 55. Berrettini W, Ferraro T, Choi H, et al. Linkage studies of bipolar illness. *Arch Gen Psychiatry* 1997;54:32–39
 56. Nurnberger Jr, Berrettini W. *Psychiatric Genetics*. London, England: Chapman & Hall; 1997
 57. Davies JL, Kawaguchi Y, Bennett ST, et al. A genome-wide search for human type 1 diabetes susceptibility genes. *Nature* 1994;371(6493):130–136
 58. Aitman TJ, Todd JA. Molecular genetics of diabetes mellitus. *Baillieres Clin Endocrinol Metab* 1995;9(3):631–656
 59. Thibonnier M, Schork NJ. The genetics of hypertension. *Curr Opin Genet Dev* 1995;5:362–370
 60. O'Connor DT, Kailasam MT, Parmer RJ. Complex trait genetics: new methods yield a result for essential hypertension. *J Clin Invest* 1996;97:1997–1998
 61. Philibert RA, Egeland JA, Paul SM, et al. The inheritance of bipolar affective disorder: abundant genes coming together. *J Affect Disord* 1997;43(1):1–3
 62. Blackwood DHR, He L, Morris SW, et al. A locus for bipolar affective disorder on chromosome 4p. *Nature Genet* 1996;12:427–430
 63. Ginns EI, Ott J, Egeland JA, et al. A genome-wide search for chromosomal loci linked to bipolar affective disorder in the Old Order Amish. *Nature Genet* 1996;12:431–435
 64. Freimer NB, Reus VI, Escamilla MA, et al. Genetic mapping using haplotype, association and linkage methods suggests a locus for severe bipolar disorder (BPI) at 18q22-q23. *Nature Genet* 1996;12:436–441
 65. Risch N, Botstein D. A manic depressive history [news]. *Nature Genet* 1996;12:351–353
 66. Steen VM, Gulbrandsen AK, Eiken HG, et al. Lack of genetic variation in the coding region of the myo-inositol monophosphatase gene in lithium-treated patients with manic depressive illness. *Pharmacogenetics* 1996;6(1):113–116
 67. Sjoholt G, Molven A, Lovlie R, et al. Genomic structure and chromosomal localization of a human myo-inositol monophosphatase gene (IMPA). *Genomics* 1997;45(1):113–122
 68. van den Boogaart A, Ala-Korpela M, Jokisaari J, et al. Time and frequency domain analysis of NMR data compared: an application to 1D 1H spectra of lipoproteins. *Magn Reson Med* 1994;31:347–358
 69. deBeer R, van den Boogaart A, van Ormondt D, et al. Application of time-domain fitting in the quantification of in vivo 1H spectroscopic imaging data sets. *NMR Biomed* 1992;5(4):171–178
 70. Moore GJ, Bechuk JM, Parrish JK, et al. Lithium induced neurochemical changes in bipolar disorder: in vivo investigation of the inositol depletion hypothesis. In: *Proceedings of the International Society of Magnetic Resonance in Medicine*; April 18–24, 1998; Sydney, Australia. Page 504
 71. Stabel S, Parker PJ. Protein kinase C. *Pharmacol Ther* 1991;51:71–95
 72. Huang KP. The mechanism of protein kinase C activation. *Trends Neurosci* 1989;12:425–432
 73. Manji HK, Chen G, Hsiao JK, et al. Regulation of signal transduction pathways by mood-stabilizing agents: implications for the delayed onset of therapeutic efficacy. *J Clin Psychiatry* 1996;57(suppl 13):34–46
 74. Wang HY, Friedman E. Lithium inhibition of protein kinase C activation-induced serotonin release. *Psychopharmacology (Berl)* 1989;99:213–218
 75. DeGrann PN, Schrama LH, Heemskerk FM, et al. The role of protein kinase C substrate B-50 (GAP-43) in neurotransmitter release and long-term potentiation. *Adv Exp Med Biol* 1990;268:347–358
 76. Robinson PJ. The role of protein kinase C and its neuronal substrates dephosphin, B-50, and MARCKS in neurotransmitter release. *Mol Neurobiol* 1991;5:87–130
 77. Lenox RH, Watson DG, Patel J, et al. Chronic lithium administration alters a prominent PKC substrate in rat hippocampus. *Brain Res* 1992;570:333–340
 78. Manji HK, Etcheberrigaray R, Chen G, et al. Lithium dramatically decreases membrane-associated PKC in the hippocampus: selectivity for the alpha isozyme. *J Neurochem* 1993;61:2303–2310
 79. Chen G, Manji HK, Hawver DB, et al. Chronic sodium valproate selectively decreases protein kinase C α and ϵ in vitro. *J Neurochem* 1994;63:2361–2364
 80. Conn PJ, Sweatt JD. Protein kinase C in the nervous system. In: Kuo JF, ed. *Protein Kinase C*. New York, NY: Oxford University Press; 1994:199–235
 81. Manji HK, Potter WZ. Emerging strategies in affective disorders. In: Pullan L, Patel J, eds. *Emerging Strategies in Neurotherapeutics*. Totowa, NJ: Humana Press; 1995:35–83
 82. Jordan VC. A current view of tamoxifen for the treatment of breast cancer. *Br J Pharmacol* 1994;110:507–517
 83. Catherino WH, Jordan VC. A risk-benefit assessment of tamoxifen therapy. *Drug Saf* 1993;8:381–397
 84. Couldwell WT, Weiss MH, DeGiorgio CM, et al. Clinical and radiographic response in patients with recurrent malignant gliomas treated with high-dose tamoxifen. *Neurosurgery* 1993;32:485–489
 85. Bechuk JM, Arfken CL, Dolan-Manji S, et al. A preliminary investigation of a protein kinase C inhibitor (tamoxifen) in the treatment of acute mania. *Arch Gen Psychiatry*. In press
 86. Freidman E, Hoau YW, Levinson D, et al. Altered platelet protein kinase C activity in bipolar affective disorder, manic episode. *Biol Psychiatry* 1993;33:520–525
 87. Wang HY, Friedman E. Enhanced protein kinase C activity and translocation in bipolar affective disorder brains. *Biol Psychiatry* 1996;40:568–575
 88. Mork A, Geisler A, Hollund P. Effects of lithium on second messenger systems in the brain. *Pharmacol Toxicol* 1992;71(suppl 1):4–17
 89. Risby ED, Hsiao JK, Manji HK, et al. The mechanisms of action of lithium. *Arch Gen Psychiatry* 1991;48:513–524
 90. Ui M. Pertussis toxin as a valuable probe for G protein involvement in signal transduction. In: Moss J, Vaughn M, eds. *ADP-Ribosylation Toxins and G Proteins*. Washington, DC: American Society for Microbiology; 1990
 91. Hsiao JK, Manji HK, Chen GA, et al. Lithium administration modulates platelet G_i in humans. *Life Sci* 1992;50:227–233
 92. Masana MI, Bitran JA, Hsiao JK, et al. In vivo evidence that lithium inactivates G_i modulation of adenylate cyclase in brain. *J Neurochem* 1992;59:200–205
 93. Mann JJ, Oquendo M, Underwood MD, et al. The neurobiology of suicide risk: a review for the clinician. *J Clin Psychiatry* 1999;60(suppl 2):7–11
 94. Manji HK, Hsiao JK, Risby ED, et al. The mechanisms of action of lithium. *Arch Gen Psychiatry* 1991;48:505–512
 95. Kaplan JR, Muldoon MF, Manuck SB, et al. Assessing the observed relationship between low cholesterol and violence-related mortality: implications for suicide risk. *Ann N Y Acad Sci* 1997;836:57–80
 96. Maltese WA. Posttranslational modification of proteins by isoprenoids in mammalian cells. *FASEB J* 1990;4:3319–3328
 97. Casey PJ. Mechanisms of protein prenylation and role in G protein function. *Biochem Soc Trans* 1995;23:161–166
 98. Goldstein LG, Brown MS. Regulation of the mevalonate pathway. *Nature* 1990;343:425–430
 99. Helper JR, Gilman AG. G proteins. *Trends Biochem Sci* 1992;17:383–387
 100. Levis MJ, Bourne HR. Activation of the α subunit of G_s in intact cells alters its abundance, rate of degradation, and membrane activity. *J Cell Biol* 1992;119:1297–1307
 101. Wedegaertner PB, Wilson PT, Bourne HR. Lipid modifications of trimeric G proteins. *J Biol Chem* 1995;270:503–506
 102. Iniguez-Lluhi JA, Simon MI, Robishaw JD, et al. G protein $\beta\gamma$ subunits synthesized in Sf9 cells. *J Biol Chem* 1992;267:23409–23417
 103. Repko EM, Maltese WA. Post-translational isoprenylation of cellular proteins is altered in response to mevalonate availability. *J Biol Chem* 1989;264:9945–9952
 104. Chiloeches A, Lasa M, Brihuega F, et al. Effects of lovastatin on adenylate cyclase activity and G proteins in GH4C1 cells. *FEBS Lett* 1995;361:46–50
 105. Lasa M, Chiloeches A, Garcia N, et al. Lovastatin decreases prolactin and growth hormone gene expression in GH4C1 cells through a cAMP dependent mechanism. *Mol Cell Endocrinol* 1997;130:93–100
 106. Kreuzer J, Schmidts A, Marquetant R, et al. Protein kinase C activation after cellular adhesion on fibronectin: partial suppression after inhibition of protein isoprenylation. *Eur J Med Res* 1997;2:305–310
 107. Purpura DP, Shofer RJ. Excitatory action of dibutyryl cyclic adenosine monophosphate on immature cerebral cortex. *Brain Res* 1972;38:179–181
 108. Gessa GA, Krishna G, Forn J, et al. Behavioral and vegetative effects produced by dibutyryl cyclic AMP injected into different areas of the brain.

- In: Greengard P, Costa E, eds. *Advances in Biochemical Psychopharmacology*, vol 3. New York, NY: Raven Press; 1970:371–381
109. Kuriyama K, Kakita K. Cholera toxin induced epileptogenic focus: an animal model for studying roles of cyclic AMP in the establishment of epilepsy. In: Battistin L, ed. *Neurochemistry and Clinical Neurology*. New York, NY: Alan R Liss; 1980:141–155
 110. Ludvig N, Moshe SL. Different behavioral and electrographic effects of acoustic stimulation and dibutyryl cyclic AMP injection into the inferior colliculus in normal and in genetically epilepsy-prone rats. *Epilepsy Res* 1989;3:185–190
 111. Ludvig N, Mischra PK, Yan QS, et al. The combined EEG-intracerebral microdialysis technique: a new tool for neuropharmacological studies on freely behaving animals. *J Neurosci Lett* 1992;43:129–137
 112. Hudson CJ, Young LT, Li PP, et al. CNS signal transduction in the pathophysiology and pharmacotherapy of affective disorders and schizophrenia. *Synapse* 1993;13:278–293
 113. Chen G, Hawver D, Wright C, et al. Attenuation of adenylyl cyclases by carbamazepine in vitro. *J Neurochem* 1996;67:2079–2086
 114. Hyman SE, Nestler EJ. Initiation and adaptation: a paradigm for understanding psychotropic drug action. *Am J Psychiatry* 1996;153:151–162
 115. Karin M, Smeal T. Control of transcription factors by signal transduction pathways: the beginning of the end. *Trends Biochem Sci* 1992;17:418–422
 116. Hughes P, Dragunow M. Induction of immediate-early genes and the control of neurotransmitter-regulated gene expression within the nervous system. *Pharmacol Rev* 1995;47:133–178
 117. Jope RS, Song L. AP-1 and NF- κ B stimulated by carbachol in human neuroblastoma SH-SY5Y cells are differentially sensitive to inhibition by lithium. *Mol Brain Res* 1997;50:171–180
 118. Ozaki N, Chuang DM. Lithium increases transcription factor binding to AP-1 and cyclic AMP-responsive element in cultured neurons and rat brain. *J Neurochem* 1997;69:2336–2344
 119. Unlap MT, Jope RS. Lithium attenuates nerve growth factor-induced activation of AP-1 DNA binding activity in PC12 cells. *Neuropsychopharmacology* 1997;17(1):12–17
 120. Williams MB, Jope RS. Circadian variation in rat brain AP-1 DNA binding activity after cholinergic stimulation: modulation by lithium. *Psychopharmacology (Berl)* 1995;122(4):363–368
 121. Yuan PX, Chen G, Manji HK. Concordant regulation of gene expression by lithium and valproic acid in vitro. In: Abstracts of the 26th Annual Meeting of the Society of Neuroscience; November 16–21, 1996; Washington, DC
 122. Chen G, Yuan PX, Hawver DB, et al. Increase in AP-1 transcription factor DNA binding activity by valproic acid. *Neuropsychopharmacology* 1997;16:238–245
 123. Chen G, Yuan PX, Manji HK. Regulation of transcription factor DNA binding activity by mood stabilizing agents. Presented at the 36th annual meeting of the American College of Neuropsychopharmacology; December 8–12, 1997; Kamuela, Hawaii
 124. Ozaki N, Chuang D-M. Effect of lithium on transcription factor binding in cultured cerebellar granule cells and the brain of rats. *J Neurochem* 1997;69:2336–2344
 125. Yuan PX, Chen G, Huang LD, et al. Lithium stimulates gene expression through the AP-1 transcription factor pathway. *Mol Brain Res* 1998;5819:225–230
 126. Kumer SC, Vrana KE. Intricate regulation of tyrosine hydroxylase activity and gene expression. *J Neurochem* 1996;67:443–461
 127. Drevets WC, Videen TO, Price JL, et al. A functional anatomical study of unipolar depression. *J Neurosci* 1992;12:3628–3641
 128. Drevets WC, Price JL, Simpson JR Jr, et al. Subgenual prefrontal cortex abnormalities in mood disorders. *Nature* 1997;386:824–827
 129. Soares JC, Mann JJ. The functional neuroanatomy of mood disorders. *J Psychiatr Res* 1997;1:393–432
 130. Ketter TA, George MS, Kimbrell TA, et al. Neuroanatomical models and brain imaging studies. In: Joffe RT, Young LT, eds. *Bipolar Disorder: Biological Models and Their Clinical Application*. New York, NY: Marcel Dekker; 1997:179–217
 131. Chen G, Yuan PX, Jiang Y, et al. Lithium increases tyrosine hydroxylase levels both in vivo and in vitro. *J Neurochem* 1998;90:1768–1771
 132. Manji HK, Potter WZ. Monoaminergic mechanisms. In: Joffe RT, Young LT, eds. *Bipolar Disorder: Biological Models and Their Clinical Application*. New York, NY: Marcel Dekker; 1997:1–40
 133. Boyle WJ, Smeal T, Defize LH, et al. Activation of protein kinase C decreases phosphorylation of c-Jun at sites that negatively regulate its DNA-binding activity. *Cell* 1991;64:573–584
 134. Lin A, Smeal T, Binetruy B, et al. Control of AP-1 activity by signal transduction cascades. *Adv Second Messenger Phosphoprotein Res* 1993;28:255–260
 135. Hedgepeth CM, Conrad LJ, Zhang J, et al. Activation of the Wnt signaling pathway: a molecular mechanism for lithium action. *Dev Biol* 1997;185:82–91
 136. Klein PS, Melton DA. A molecular mechanism for the effect of lithium on development. *Proc Natl Acad Sci* 1996;93:8455–8459
 137. Stambolic V, Ruel L, Laurent R, et al. Lithium inhibits glycogen synthase kinase-3 activity and mimics wingless signalling in intact cells. *Curr Biol* 1996;6:1664–1668
 138. Chen G, Manji HK. Inhibition of glycogen synthase kinase-3 by the anti-convulsant and anti manic agent valproic acid. Presented at the 27th annual meeting of the Society for Neuroscience; October 25–30, 1997; New Orleans, La